

# SOUND BUILDING

# S U P P L Y

sales@soundbuilding.com

8939 S. 190th St  
Kent, WA 98032  
425-284-0284 Ph  
425-284-0385 Fax

Customer: \_\_\_\_\_

SBS Sales Rep: \_\_\_\_\_

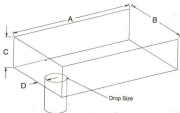

## Box Scupper Quote Sheet

A = \_\_\_\_\_  
B = \_\_\_\_\_  
C = \_\_\_\_\_  
D = \_\_\_\_\_  
Drop Size & Length = \_\_\_\_\_

Material = \_\_\_\_\_

Quantity = \_\_\_\_\_

Price = \_\_\_\_\_

**Sound-Lok**

By Sound Building Supply

**Sound Total Care**

By Sound Building Supply



# SOUND BUILDING SUPPLY

sales@soundbuildingsupply.com

8939 S. 190th St  
Kent, WA 98031  
425-264-0264 Ph  
425-264-0265 Fax

Customer: \_\_\_\_\_

SBS Sales Rep: \_\_\_\_\_

Material = \_\_\_\_\_

Gauge = \_\_\_\_\_

Pitch = \_\_\_\_\_

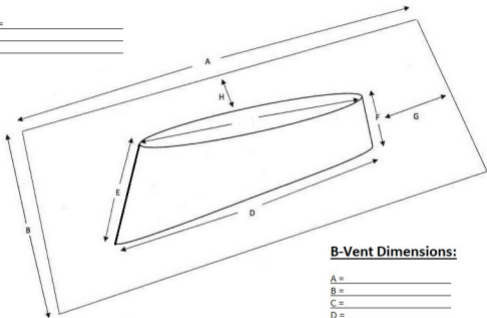

### B-Vent Dimensions:

A = \_\_\_\_\_

B = \_\_\_\_\_

C = \_\_\_\_\_

D = \_\_\_\_\_

E = \_\_\_\_\_

F = \_\_\_\_\_

G = \_\_\_\_\_

H = \_\_\_\_\_

**Sound-Lok**

by Sound Building Supply

**Sound Total Care**

by Sound Building Supply

# SOUND BUILDING SUPPLY

sales@soundbuildingsupply.com

8939 S. 190th St  
Kent, WA 98031  
425-264-0264 Ph  
425-264-0265 Fax

Customer: \_\_\_\_\_

SBS Sales Rep: \_\_\_\_\_

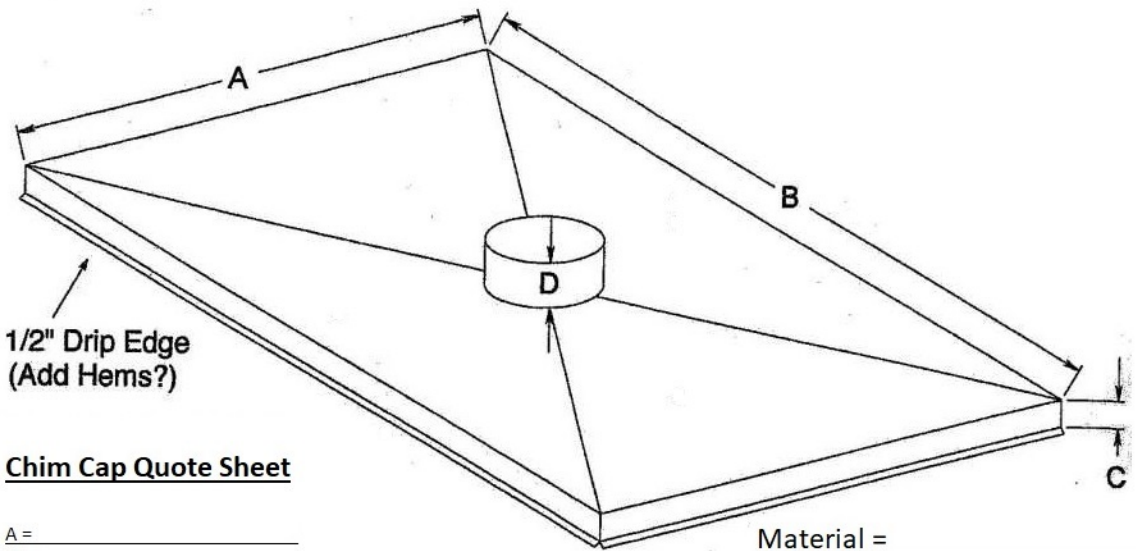

## Chim Cap Quote Sheet

A = \_\_\_\_\_  
 B = \_\_\_\_\_  
 C = \_\_\_\_\_  
 D = \_\_\_\_\_  
 Hole Size = \_\_\_\_\_  
 1/2" Drips with Hems? = Y / N  
 Crossbrakes? = Y / N

Material = \_\_\_\_\_

Quantity = \_\_\_\_\_

Price = \_\_\_\_\_

**Sound-Lok**  
 by Sound Building Supply

**Sound Total Care**  
 by Sound Building Supply

# SOUND BUILDING

# S U P P L Y

sales@soundbuildingsupply.com

8939 S. 190th St  
Kent, WA 98031  
425-264-0264 Ph  
425-264-0265 Fax

Customer: \_\_\_\_\_

SBS Sales Rep: \_\_\_\_\_

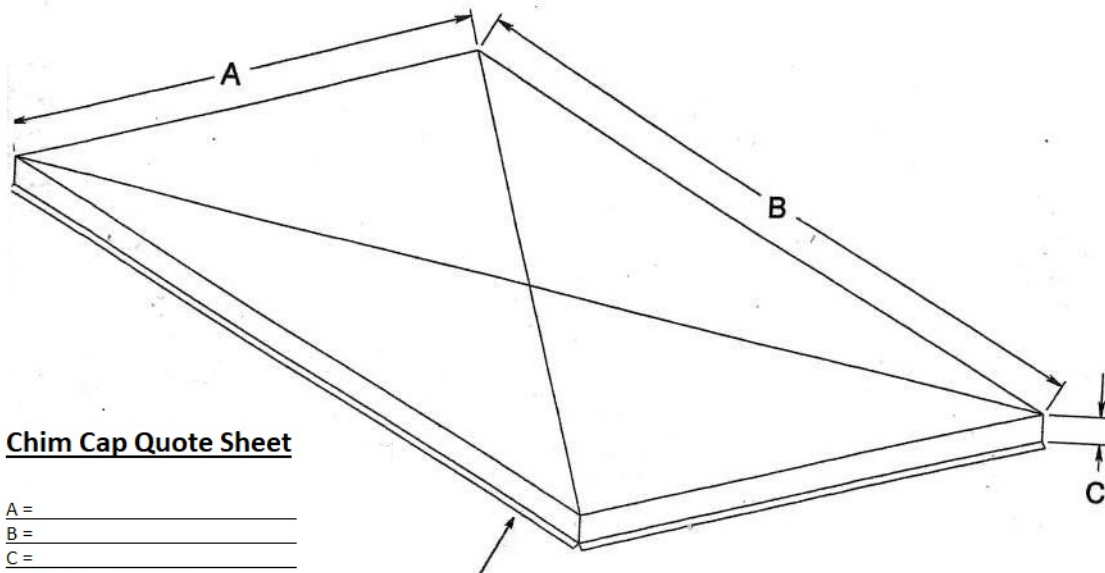

## Chim Cap Quote Sheet

A = \_\_\_\_\_

B = \_\_\_\_\_

C = \_\_\_\_\_

1/2" Drips with Hems? = Y / N

Crossbrakes? = Y / N

1/2" Drip Edge  
(Add Hems?)

Material = \_\_\_\_\_

Quantity = \_\_\_\_\_

Price = \_\_\_\_\_

**Sound-Lok**

by Sound Building Supply

**Sound Total Care**  
by Sound Building Supply

Customer: \_\_\_\_\_

SBS Sales Rep: \_\_\_\_\_

**Collector Box Quote Sheet**

A = \_\_\_\_\_

B = \_\_\_\_\_

C = \_\_\_\_\_

D = \_\_\_\_\_

E = \_\_\_\_\_

F = \_\_\_\_\_

Gross Size & Length = \_\_\_\_\_

Material = \_\_\_\_\_

Quantity = \_\_\_\_\_

Price = \_\_\_\_\_

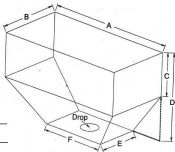

Customer: \_\_\_\_\_

SBS Sales Rep: \_\_\_\_\_

**Custom Cone Template:**

A = \_\_\_\_\_  
B = \_\_\_\_\_  
C = \_\_\_\_\_  
D = \_\_\_\_\_  
E = \_\_\_\_\_

Material = \_\_\_\_\_

Quantity = \_\_\_\_\_

Price = \_\_\_\_\_

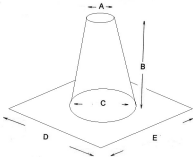

Customer: \_\_\_\_\_

SBS Sales Rep: \_\_\_\_\_

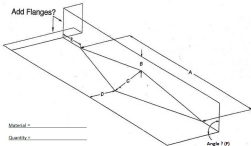

## Cricket Dimensions

A = \_\_\_\_\_

B = \_\_\_\_\_

C = \_\_\_\_\_

D = \_\_\_\_\_

E = \_\_\_\_\_

F = \_\_\_\_\_

G = \_\_\_\_\_

Flanges? \_\_\_\_\_

Rigid Flange

Membrane Flange

Material = \_\_\_\_\_

Quantity = \_\_\_\_\_

Price = \_\_\_\_\_

**Sound-Lok**

by Sound Building Supply

**Sound Total Care**

by Sound Building Supply

Door Pan Dimensions

- A = \_\_\_\_\_
- B = \_\_\_\_\_
- C = \_\_\_\_\_
- D = \_\_\_\_\_
- E = \_\_\_\_\_
- F = \_\_\_\_\_

Material = \_\_\_\_\_

Quantity = \_\_\_\_\_

Price = \_\_\_\_\_

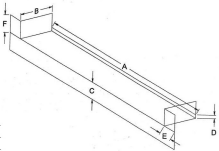



# SOUND BUILDING SUPPLY

sales@soundbuilding.com

8939 S. 190th St  
Kent, WA 98032  
425-264-0284 Ph  
425-264-0285 Fax

Customer: \_\_\_\_\_

SBS Sales Rep: \_\_\_\_\_

## Flow Thru Scupper Cant

- A = \_\_\_\_\_
- B = \_\_\_\_\_
- C = \_\_\_\_\_
- D = \_\_\_\_\_
- E = \_\_\_\_\_
- F = \_\_\_\_\_
- G = \_\_\_\_\_

Material = \_\_\_\_\_

Quantity = \_\_\_\_\_

Price = \_\_\_\_\_

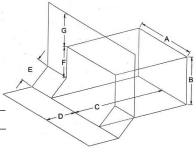

# SOUND BUILDING SUPPLY

sales@soundbuilding.com

8933 S. 150th St  
Kent, WA 98032  
425-264-0284 Pk  
425-264-0285 Fax

Customer: \_\_\_\_\_

SBS Sales Rep: \_\_\_\_\_

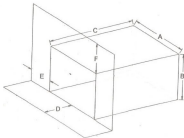

## Flow Through Scupper

- A = \_\_\_\_\_
- B = \_\_\_\_\_
- C = \_\_\_\_\_
- D = \_\_\_\_\_
- E = \_\_\_\_\_
- F = \_\_\_\_\_

Rigid Flange

Membrane Flange

If flange (D, E, & F) is smaller than 8 inches - no railing tab

Material = \_\_\_\_\_

Quantity = \_\_\_\_\_

Price = \_\_\_\_\_

**Sound-Lok**

by Sound Building Supply

**Sound Total Care**

by Sound Building Supply

# SOUND BUILDING SUPPLY

sales@soundbuilding.com

8933 S. 150th St  
Kent, WA 98032  
425-264-0284 Pk  
425-264-0285 Fax

Customer: \_\_\_\_\_

SBS Sales Rep: \_\_\_\_\_

## Flow Through Scupper

A = \_\_\_\_\_  
B = \_\_\_\_\_  
C = \_\_\_\_\_  
D = \_\_\_\_\_  
E = \_\_\_\_\_  
F = \_\_\_\_\_

Rigid Flange

Membrane Flange

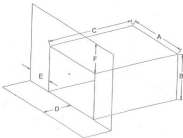

Material = \_\_\_\_\_

Quantity = \_\_\_\_\_

Price = \_\_\_\_\_

**Sound-Lok**

by Sound Building Supply

**Sound Total Care**

by Sound Building Supply

# SOUND BUILDING SUPPLY

sales@soundbuilding.com

8035 S. 190th St  
Renton, WA 98031  
425-264-0364 Ph  
425-264-0365 Fax

Customer: \_\_\_\_\_

SBS Sales Rep: \_\_\_\_\_

### Inside Corner Quote Sheet

- A= \_\_\_\_\_
- B= \_\_\_\_\_
- C= \_\_\_\_\_
- D= \_\_\_\_\_
- E= \_\_\_\_\_
- F= \_\_\_\_\_
- Z= \_\_\_\_\_

Material = \_\_\_\_\_

Quantity = \_\_\_\_\_

Price = \_\_\_\_\_

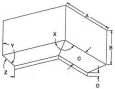

**Sound-Lok**  
by Sound Building Supply

**Sound Total Care**  
by Sound Building Supply

Customer: \_\_\_\_\_

SBS Sales Rep: \_\_\_\_\_

## Outside Corner Quote Sheet

A = \_\_\_\_\_  
B = \_\_\_\_\_  
C = \_\_\_\_\_  
D = \_\_\_\_\_  
E = \_\_\_\_\_  
X = \_\_\_\_\_  
Y = \_\_\_\_\_  
Z = \_\_\_\_\_

Material = \_\_\_\_\_

Quantity = \_\_\_\_\_

Price = \_\_\_\_\_

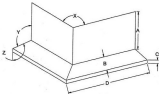

**Sound-Lok**

by Sound Building Supply

**Sound Total Care**

by Sound Building Supply



# SOUND BUILDING

# S U P P L Y

sales@soundbuildingsupply.com

8939 S. 190th St  
Kent, WA 98031  
425-264-0264 Ph  
425-264-0265 Fax

Customer: \_\_\_\_\_

SBS Sales Rep: \_\_\_\_\_

## Rectangular Louvered Vent

A = \_\_\_\_\_

B = \_\_\_\_\_

C = \_\_\_\_\_

D = \_\_\_\_\_

Frame: 24GA Steel

Louver: 24GA Steel

Screen: 1/4" Galv.

Material = \_\_\_\_\_

Quantity = \_\_\_\_\_

Price = \_\_\_\_\_

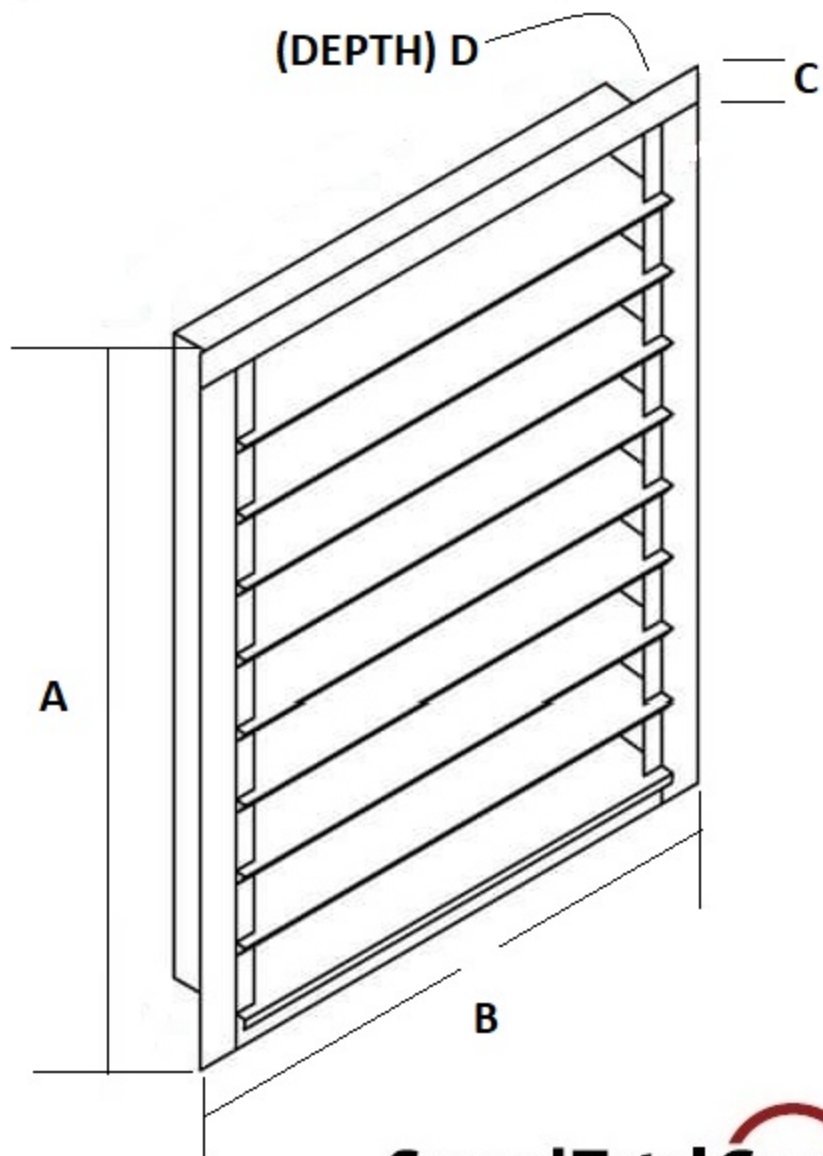

## Sound-Lok

by Sound Building Supply

## Sound Total Care

by Sound Building Supply



# SOUND BUILDING S U P P L Y

sales@soundbuildingssupply.com

8838 S. 150th St.  
Kent, WA 98032  
425-264-8264 Ph  
425-264-8265 Fax

Customer: \_\_\_\_\_

SBS Sales Rep: \_\_\_\_\_

## Saddle Flashing Quote Sheet

A = \_\_\_\_\_  
B = \_\_\_\_\_  
C = \_\_\_\_\_  
E = \_\_\_\_\_

Material = \_\_\_\_\_

Quantity = \_\_\_\_\_

Price = \_\_\_\_\_



**Sound-Lok**

by Sound Building Supply

**Sound Total Care**

by Sound Building Supply



# SOUND BUILDING SUPPLY

sales@soundbuildingupply.com

8937 S. 190th St  
Kent, WA 98031  
425-264-0264 Ph  
425-264-0265 Fax

Customer: \_\_\_\_\_

SBS Sales Rep: \_\_\_\_\_

## Skylight Pan Quote Sheet

A = \_\_\_\_\_

B = \_\_\_\_\_

C = \_\_\_\_\_

D = \_\_\_\_\_

E = \_\_\_\_\_

Skylight Pans will be overlapped  
for best waterproofing

Material = \_\_\_\_\_

Quantity = \_\_\_\_\_

Price = \_\_\_\_\_

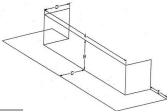

**Sound-Lok**

by Sound Building Supply

**Sound Total Care**  
by Sound Building Supply